



STC-1850
User's Manual



Toll Free Customer Support 1-877-269-8490

www.stealthcam.net

STC-I850

For Customer Service or Warranty Information Call Toll Free

877-269-8490

Stealth Cam, LLC

P.O. Box 539504

Grand Prairie, TX 75053-9504

www.stealthcam.net

Stealth Cam Limited Warranty

Your Stealth Cam scouting camera is covered by a One Year Limited Warranty on parts and labor from the date of original purchase, and purchases must be made through an authorized dealer. The warranty covers defects in workmanship and materials. The warranty does not apply to units, which have been damaged or abused intentionally or unintentionally. A purchase from individuals or unauthorized internet sites such as eBay voids the warranty.

Tampering with or altering the unit will void the warranty. Any unauthorized service will void warranty. Original sales receipt must be produced for any warranty service and a Return Authorization (RA) number must be obtained from customer service at 877-269-8490 prior to returning product.

www.stealthcam.net

Toll Free 877-269-8490

Manual Contents

Camera overview	4
Camera kit contents	7
Battery and memory installation	8
Set up and programming	12
Camera use	19
Mounting the camera	20
Viewing & deleting images	25
Memory compatibility chart	33
Technical specs	34
General information	37
Image capacity chart	39
Moon phase chart	41

STC-I850

Camera overview

Front housing image with major parts indication

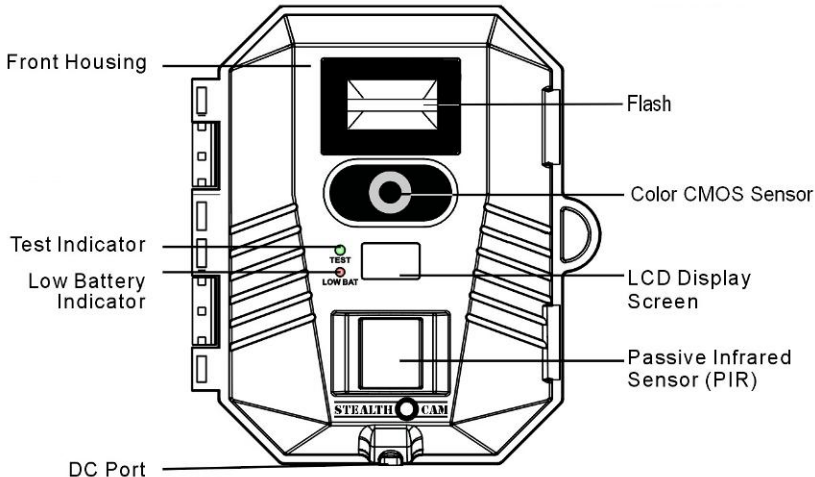

STC-I850

Open view image with major parts indication

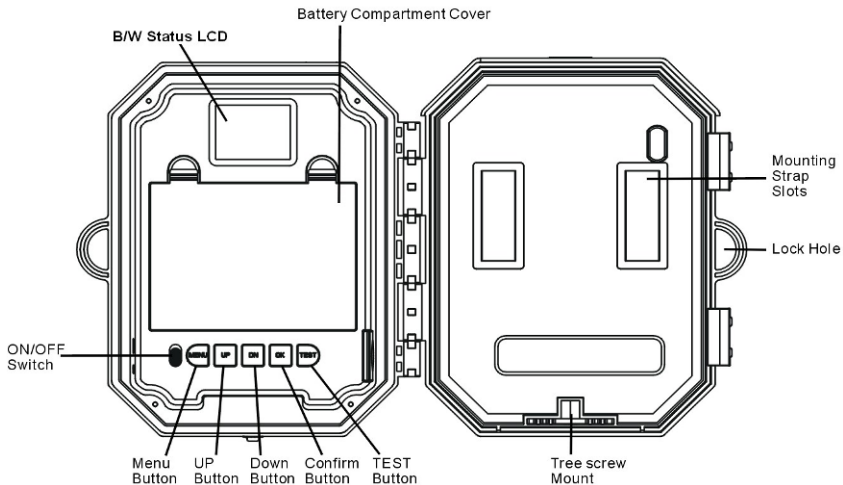

STC-I850

Side view with major parts indication

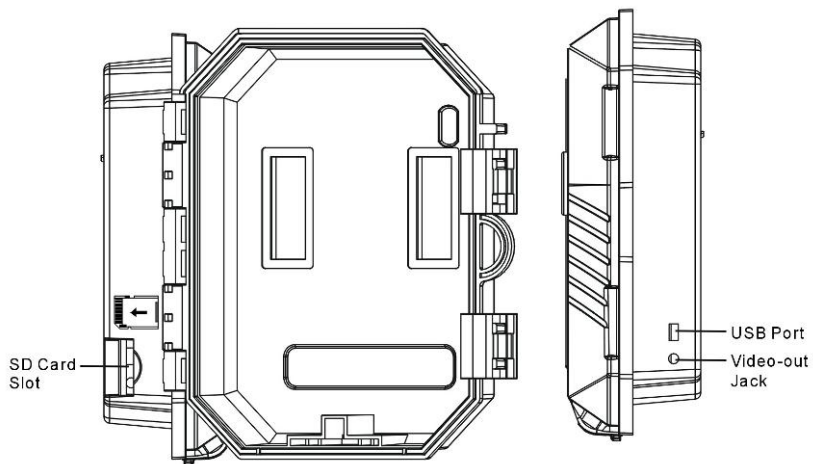

STC-I850

Camera kit contents

- Model STC-I850 Digital Scouting Camera
- User manual
- USB cable
- Strap

Battery & memory installation

Warning: Do not use different voltage lead acid battery other than the one specified in this section. Doing so will damage the camera and will void the warranty.

Your Stealth Cam Advanced Digital Scouting Camera is designed to operate using two different types of battery power options.

NOTE: Always have camera in the OFF position when installing or removing batteries. Removing battery while the camera is in operation may damage the camera.

Batteries “C” cell

The internal battery compartment accepts 6 “C” cell batteries. Be sure to use high quality brand name alkaline batteries. Install batteries with correct polarity (+/-) as noted inside the battery compartment.

STC-I850

12V Lead Acid external battery

The camera is equipped with an external power jack designed to accept a barrel plug cable that attaches to a sealed lead acid battery. (sold separately). Battery cable and complete 12V Lead Acid battery kits are available wherever Stealth Cam scouting cameras are sold, or call toll free 877-269-8490. Only Stealth Cam external battery accessories are recommended.

- Insert the external battery barrel plug into the DC 12V jack on the bottom of camera housing.
- Turn the camera power on.
- ❖ ***Please make sure the voltage and polarity (+/-) are correct before connection. Incorrect voltage or polarity (+/-) will damage the camera.***

Please note: When both internal and external batteries are connected, the camera will draw power from the higher voltage source first.

Memory Options

Your camera is equipped with 32MB built in flash memory. The camera is also equipped with an expandable media card slot capable of accepting up to 2GB SD card (sold separately). With no memory card inserted into the slot, the camera will use the built in 32MB memory. If an SD card is inserted into the slot, then the camera will bypass the built in memory and utilize the SD memory. The front counter display will show the number of images on the built in memory unless the expansion card is inserted at which point the counter will only show the number of images in the expansion card.

Inserting the SD card

Make sure camera is in the OFF position whenever adding or removing memory.

- Insert SD memory card into the SD card slot completely and in the correct direction, as shown by the sticker located at the side of the housing.
- To remove the SD memory card, depress the SD card and pull out the card gently.

STC-I850

- ❖ ***SD cards must be clean (no images from other sources).***
- ❖ ***If you are using the SD card from other cameras, please make sure to format the SD card in your computer prior to use in your camera. New cards are good to use straight from the package.***



Set up and Programming

When the camera is first turned on, the internal LCD screen displays the camera status. The following information is present on this screen.



Flash Mode Control:

The camera is pre-programmed with Auto Flash setting.



- Switch the camera to ON position.
- To turn off the flash mode, press the [UP] button  once within 30 seconds.  icon will appear in the status screen.
- To turn the flash mode back to Auto setting, press the [UP] button the second time.  icon will appear on the top of the screen.

If no buttons are pressed after 30 seconds, the LCD screen will power down to conserve battery life and enter 1 minute count down to enter PIR detection mode. To re-power the display screen, press and hold the UP or DOWN button until you see the status screen.

Definition

- **Time out:** To set the amount of time in minutes the camera will sleep between PIR triggering.
- **Flash:**
 - Auto – Flash based on surrounding light conditions.
 - Off – Turn off the flash.
- **Capture mode:**
 - **1P ~ 9P:** 1 to 9 burst mode image capturing per PIR triggering.
 - **Video:** 5 to 90 seconds adjustable video per PIR triggering.
- **Resolution:**
 - **High:** Select this option to capture an 8.0M pixels image. (High image quality)
 - **Low:** Select this option to capture a 3.0M pixels image. (Low image quality)
 - **Base:** Select this option to capture a 1.3M pixels image. (Base image quality)
 - **Video resolution (640 x 480):** The resolution during video capturing.

STC-I850

- **Batteries Status:** Displays the battery status.
 - **Full:** The battery is full. 
 - **Low:** The battery is low, and the front Low Battery indicator will also blink. 
- ❖ ***When the camera has detected low batteries, (Batteries that are lower than 6.0 +/-0.2Volts) the camera unit will power off within 30 seconds automatically. Please replace with new batteries; otherwise the camera will not work properly.***
- **Day and Time:** Displays the **date and time that you have set** for still image. For AVI: will appear on the first frame. (Using Quick Time Player or Windows Media Player).
- **Moon phase and Temperature:** Displays the moon phase and temperature. For AVI; will appear on the first frame. (Using Quick Time Player or Windows Media Player).

Programming the Stealth Cam

Switch the camera to the ON position. LCD screen will display the camera status screen. Press the MENU button within 30 seconds to enter programming mode.

If MENU button is not pressed within 30 seconds, camera will automatically enter PIR detection mode.

Set the Resolution: The first program setting is resolution.

- The word RESOLUTION will be blinking.
- Press [OK] to choose the selection.
- Press the [UP] or [DN] button to select the desired resolution (HIGH/LOW/BASE) and press [OK] to save and exit to CAPTURING setting.

Set the Capturing sequence. *Your Stealth Cam can be programmed to shoot 1~9 pictures per triggering.*

- The word CAMERA will be blinking.
- Press [OK] button and the number of burst modes will now blink. Press the [UP] or [DN] button to select the desired burst mode setting (number of pictures per triggering).

STC-I850

- Press [OK] to confirm your selection, and exit to TIME OUT setting.

Set the Video Mode: *Your Stealth Cam STC-I850 can be programmed to record 5~90 seconds of video per triggering.*

- After pressing the [MENU] button, press [UP] button twice to enter video setting mode. The word VIDEO will be blinking. Press [OK] button and the video length in seconds will be blinking.
- Press [UP] or [DN] button to select the desired video length (from 5 seconds to 90 seconds in 5 second increments).
- Press [OK] to save and exit to TIME OUT setting.

Set the Time out:

- The word TIME OUT will be blinking.
- Press [OK] button to choose the selection. The digits will blink.
- Press [UP] or [DN] button to increase or decrease the time value in minutes from 01 to 59 minutes.
- Press [OK] to save the setting, and exit to Date & Time setting.

STC-I850

Set Date and Time: This camera uses the 24hr military time format.

- The word TIME will be blinking. Press [OK] to enter minute setting first.
- Minutes digit will be blinking. Press [UP] or [DN] to increase or decrease the minute value (0 – 59).
- Press [OK] to confirm the minute setting, and enter hours setting.
- Hour digits will be blinking. Press [UP] or [DN] to increase or decrease the hour value (00 – 23).
- Press [OK] to confirm the hour setting, and enter year setting.
- Year digit will be blinking. Press [UP] or [DN] to increase or decrease the year value. Once this is done, press [OK] and enter month setting.
- Month digit will be blinking. Press [UP] or [DN] to increase or decrease the month value. (01 – 12).
- Press [OK] to confirm the month setting, and enter date setting.
- Date digit will be blinking. Press [UP] or [DN] to increase or

STC-I850

decrease the date value (1 – 31). Once this is done, press [OK]. The word "-- dEL --" will begin to blink. Now press [MENU] to exit the program setting, and back to status screen.

At the end of each program set up selection, you may press [MENU] to exit, and return to the camera status ready screen for the 1 minute countdown mode to enter PIR capturing.

Using the camera

Once all program settings have been completed, your Stealth Cam is ready for field use.

Getting started

It is recommended that you mount the camera 4-5 ft off the ground with the camera pointed at a slight downward angle. Be sure to avoid mounting the camera facing east or west, as the rising and setting of the sun could produce false triggers and overexposed images. Clear all branches and other debris away from the front of the camera so as not to block the camera lens or PIR sensor.

PIR Coverage Area
Diagram

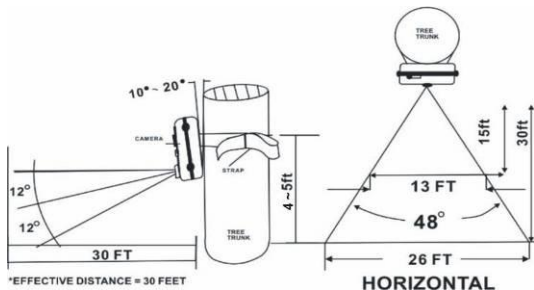

Mounting the camera

Mounting the camera with Tree Screw (optional accessory sold separately).

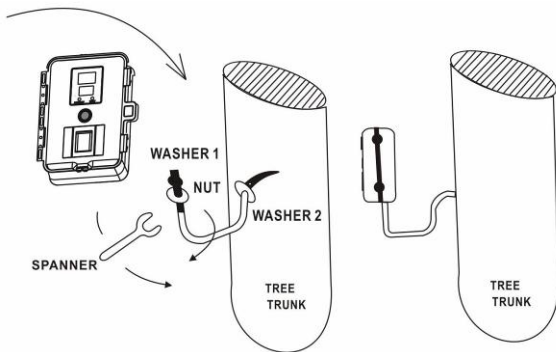

- Hand twist the screw into the tree, or post at the desired position.
- Attach the camera to the screw by turning the camera onto the mounting screw to the desired position.
- Tighten the stabilizer nut.

STC-I850

- ❖ ***Do not over tighten as this may cause damage to camera housing. Using the nut and washer that came with the tree screw, tighten to the bottom of camera for greater stability.***

Mounting the camera with the supplied strap

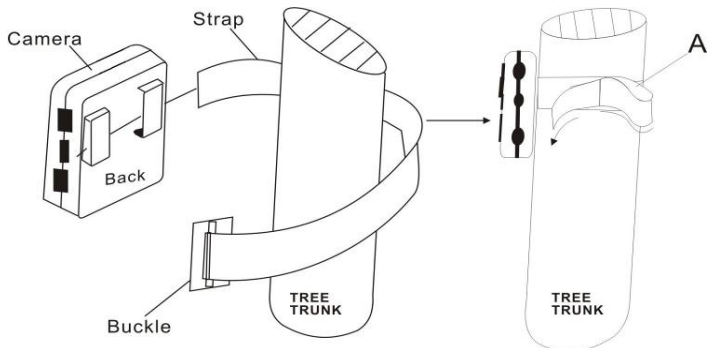

- Insert the strap through the strap slots on the rear housing.
- Wrap the strap around the mounting surface. Secure the strap and tighten the buckle in order to secure the camera.

STC-I850

Stealth Cam offers a Security Lock Bracket for uses exclusively with this camera. (Part number STC-LBDV)

For the latest Stealthcam accessories go to: www.stealthcam.net or call toll free: 877-269-8490

- ❖ ***In order to obtain proper weather resistance, please make sure that both door latches are securely locked in place.***

- After mounting the camera, open the front housing and slide the power to ON.

- After the LCD screen has powered on, press the [TEST] button (this must be done within 30 seconds or the camera will enter countdown mode).

- Close the front housing.

- Walk around in the front of the camera to see if you have mounted the camera in the proper position. A green indicator LED light on the front will blink when you have intruded the coverage area.

STC-I850

- Adjust the camera position as needed, and repeat testing until the desired coverage area is achieved.
- When you have completed testing the coverage area, there are 2 methods to exit the test mode:
 - a. Option 1: Open the front housing, and press the [TEST] button to exit test mode. The camera will then enter countdown mode for 1 minute and the front green indicator will start blinking, giving you 1 minute to leave the coverage area. The camera will then enter PIR detection mode.
 - b. Option 2: As a safety precaution, if for any reason you left the area and forgot to push the test button to exit the test mode as shown in option 1 above, the camera will automatically enter the 1 minute countdown mode after it is left in test mode for 5 minutes. Camera will then enter PIR detection mode.

Using the camera in PIR detection mode:

- Mount the camera to tree or other sturdy object using either a tree screw (optional accessory) or supplied mounting strap (You may refer to the mounting suggestions section in this manual).

STC-I850

- Open the front housing and move the switch to the ON position. At this point, you have 30 seconds to make any program adjustments.
 - After 30 seconds, the camera's green LED light will begin blinking and enter count down mode. This is your indication to leave the coverage area within one minute.
 - After one minute, the camera will enter either image burst mode or adjustable video mode, based on your program setting. The camera will then time out between 1 ~ 59 minutes, depending on your setting.
-
- ❖ *The time between motion detection, and the camera taking the pictures may vary due to lighting conditions, program settings, and battery power level.*
 - ❖ *The flash will only activate in low light conditions.*
 - ❖ *When the camera is set to AVI capturing, the video clip will turn out well in good daytime lighting conditions. If the lighting conditions are not enough, your unit will switch the AVI setting to single image capturing automatically.*

Viewing and deleting the images

The STC-I850 cam offers the user different options for viewing the images. The external LCD display on the front of the housing will show the number of images in memory.

To wake the camera from PIR detection mode, press and hold either the [UP] or [DN] button for about 5 seconds.

The instructions below are based on a camera that is turned off.

Viewing the image on a handheld LCD TV video monitor or your home TV equipped with an RCA input jack.

For viewing on handheld LCD TV, attach the appropriate cable to the video out jack on the camera. Insert the other end into the video in jack on handheld LCD TV monitor.

For viewing on home TV, attach the appropriate cable to the video out jack on the camera. Insert the other end into the RCA video in jack on the TV. **Make sure to switch to VIDEO IN mode on your TV. (See your TV owner's manual for directions)**

Turn on both the camera and TV monitor.

- Your camera is preset to NTSC TV out system by default. If

STC-I850

the handheld TV screen does not flicker, you do not need to set your TV out system. Proceed to the Thumbnail image section below. If the handheld TV screen flickers, then you will need to proceed to the next step to set up your TV out to PAL system.

- Press the [MENU] button once. The word “ tu “ on the camera’s internal screen will blink first. Press [OK] once and now you’ll see “ tu – n “ blinking.



- Press [DN] button to select TV out in PAL System (used in most European and Asian countries). The word “tu – P” will now be blinking. Press [OK] to confirm this setting.
- Press [MENU] to exit. When you see the status screen appear, power off the camera. Wait for 5 seconds and then power up your camera again.

Thumbnail Images

- You will see thumbnail images on your monitor. At this point you may use the [UP] or [DN] button to navigate through your thumbnail images.
- On the upper left hand corner of your TV monitor, it will either display the picture icon or video icon to show whether the image is a still image or video clip.
- To view image in full screen, press [OK] button. Press [OK] button again to return to the thumbnail view from the full size image.

View AVI Clip on hand held TV monitor or home TV

- Follow the cable attaching instruction listed in previous section.
- Monitor will display a thumbnail image in the memory.
- Press [UP] or [DN] button to choose the AVI clip that you would like to see.
- Press the [OK] button to play back the AVI motion clip. You may pause the video by pressing the [OK] button during the playback. Press [OK] button to resume playing.

STC-I850

- At the end of the video clip, press [UP] or [DN] button to proceed to the next video or image. If it is a video clip file, then it will automatically start to play. If it is still image file then it will show the image in full screen.
- When you view the still image in full screen, you can return to thumbnail image selection view by pressing the [OK] button.

Viewing images by computer download

Your Stealth Cam Digital Scouting Camera is a plug and play USB storage device for users of Windows 2000 / ME / XP and Vista operating systems. This camera is not MAC compatible.

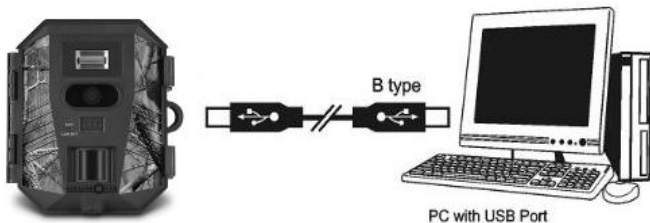

STC-I850

Viewing the images on your computer via USB connection

- Make sure the power switch is in the OFF location.
- To view the images, simply plug the larger end of the USB cable into an available USB port on your computer.
- Plug the other smaller end of USB cable into the camera. The camera will automatically power ON and display the word {USb} on the LCD screen.
- At the same time, your computer will recognize the camera as a mass storage device, and will be found under MY COMPUTER.



Deleting images

At any time while viewing images on Handheld TV or Home TV you may delete images one at a time or all at once.

- While viewing images either in thumbnail view or full screen, press [MENU] once and [UP] button once to enter delete mode. The word {--dEL} will be blinking.
- ❖ ***Please note you cannot enter delete mode while the video clip is playing. You must wait until the end of***

STC-I850

the video clip or while it is in thumbnail view.

- Press [OK] button to enter the DELETE & FORMAT menu.
- Using the [UP] and [DN] buttons to select the desired function. No Delete (NO-dL), Delete one (d-ONE), Delete ALL (d-ALL), or FORMAT.



- Press [OK] to confirm your selection.
- Press [UP] or [DN] until you see (NO-dL) then press [OK] button once and then press [MENU] to return to image viewing.
- If you choose to delete one picture at a time, (d-ONE), it will delete the picture that you selected on the thumbnail view or the image that is on full screen.
- If you choose to delete all images (d-ALL), it will delete all images. Once images are deleted from the memory, you will return to status screen.

STC-I850

- If you choose to format your memory, it will erase all images. This feature is particularly useful if you don't want to look through the images one at a time. Once this is done, press [DN] button and scroll through the options until you see No Delete (NO-dL), press [OK] and then press [MENU]. This will return to status screen.

Deleting images in the field without viewing screen

- After pressing the [MENU] button, press [DN] button once to enter the delete mode. The word "-- dEL --" blinking. Press [OK] button to enter the DELETE & FORMAT menu.
- Using the [UP] and [DN] buttons to select the desired function. No Delete (NO-dL), Delete one (d-ONE), Delete ALL (d-ALL), or FORMAT.



STC-I850

- Press [OK] to confirm your selection.
- If you choose to delete one picture at a time, (d-ONE), it will delete the last picture from the memory, the front counter will decrease by one.
- If you choose to delete all images (d-ALL), it will delete all images. Once images are deleted from the memory, you will return to status screen and front counter will return to 0000.
- If you choose to format your memory, it will erase all images. This feature is particularly useful if you don't want to look through the images one at a time.
- To exit Delete and Format menu, press [UP] or [DN] button to select No Delete (NO-dL) then press [OK], or press [MENU] to back to status screen.

STC-I850

SD Memory Card Compatibility Chart

The following cards have been tested and approved for use in the STC-I850 model.

Kingmax	2G
Sandisk	16MB, 4G
Toshiba	2G
PNY	4G
Kingston	512MB, 4G
First Champion	1G, 2G.
Digilux	1G, 2G.

Proper camera operation cannot be guaranteed when using memory card **NOT** listed above.

Technical Specifications

System Requirements and Compatibility

- Windows Me/2000/XP/Vista
- Pentium 4, 2GHz or above
- 1GB RAM (2GB recommended)
- 32 bits color, resolution 800 x 600 or above. Built in 128MB
- 2GB free hard disc space
- An available USB 1.1 port (USB 2.0 recommended)
- Direct X 9.0 or above – Should come with your operating system already
- Optional: Windows compatible sound card and speaker

❖ ***If you have any questions regarding your PC specifications, please contact your PC manufacturer.***

STC-I850

Camera Features and Specification

- Camera lens: 4P high precision multi-layer glass lens with IR coating
- Built in 2.0" B&W LCD display
- Built in 32M flash memory for image storage
- External memory support: SD memory card up to 2.0 GB
- Resolution Options: 8.0M, 3.0M, 1.3M
- Capturing Options: 1 to 9 image burst mode or AVI recording
- Image performance for video stream: VGA 640 x 480 pixels
- Auto white balance and auto expose
- Flash Auto & Off control
 - ❖ Effective Range for Still picture (up to 50 ft)
- Real time clock for date and time stamping
- 4 digits LCD image counter
- Battery low LED indicator

STC-I850

- Green test LED indicator
- TV out support for NTSC and PAL system
- Focusing: 5 ft to Infinity
- Effective viewing Angle: 50 deg.
- PIR detection angle 48 deg.
- Power consumption:
 - Standby current: < 5mA
 - Capture current <140mA
- Interface type: USB 1.1.
- Power: “C” size alkaline batteries x 6
- External power: 12 volts battery pack
- Image format: Standard JPEG or Motion JPEG (AVI)

General Information

Storing conditions

- Operating Environment: 14 to 104 deg F (-10 to 40 deg C). 20-85% relative humidity, non-condensing.

Special care instructions!!

- The camera is designed to be weather resistant. Never attempt to immerse the unit in water or any other liquid. This will damage the unit and void the warranty.
- Use a soft lens cloth for cleaning lens. Avoid touching lens with fingers.
- Remove dirt or stains with a soft cloth dampened with water or neutral detergent. Keep your camera in a dry and cool dust-free environment, or container when it is NOT used.
- Take the batteries out, when camera is NOT to be used over a long period.
- Avoid dropping your camera on to a hard surface.
- Do not disassemble your camera.
- Do not mix new and old batteries.

STC-I850

- Do not open the camera for unauthorized service. This could cause serious damage to the unit, and will void the warranty.

This camera is a precision electronic device. Do not attempt to service this camera yourself, as opening or removing covers may expose you to dangerous voltage points or other risks.

May be protected by one or more U.S. Patent numbers:

6,735,387 / 6,768,868 / 6,834,162 / 7,149,422 / 7,308,196

STC-I850
Picture / Image Capacity

SD card	High	Low	Base	AVI
Based on data Size	5.0MB	2.0MB	1.0MB	70MB
Built In 32MB	5	14	28	0
16MB	3	8	16	0
32MB	6	16	32	0
64MB	12	32	64	0
128MB	24	64	128	1
256MB	48	128	256	3
512MB	96	256	512	6
1GB*	192	512	1,024	12
2GB*	384	1,024	2,048	24





































*Subject to card compatibility under different brands.

STC-I850

NOTE: Picture / Image Capacity Chart provides approximate number of images or AVI movies based on resolution settings and the size of memory card. These figures may vary depending on the amount of detail in the image.

STC-I850

Moon Phase Symbol Chart

Symbol	Lunation from to		Actual phase				
	1	5					
	6	10					
	11	14					
	15	16					
	17	20					
	21	25					
	26	29 or 30					

STC-I850

Caution:

Modification not approved by the party responsible for compliance could void user's authority to operate the equipment.

FCC Compliance

This equipment has been tested and found to comply with the limits for Class B digital device, pursuant to part 15 of the FCC Rules. These limits are designed to provide reasonable protection against harmful interference in a residential installation. This equipment generates uses and can radiate radio frequency energy and, if not installed and used in accordance with the instructions, may cause harmful interference to radio or television receptions, which can be determined by turning the equipment off and on, the user is encouraged to try to correct the interference by one or more of the following measure:

- ❖ Reorient or relocate the receiving antenna.
- ❖ Increase the separation between the equipment and the receiver.
- ❖ Connect the equipment into an outlet on a circuit different from that to which the receiver is connected.
- ❖ Consult the dealer or an experienced radio/TV technician for help.

Product specifications are subject to change. Stealthcam is not responsible for any photographic or typographical errors.