

Stealth Cam
STC-I590
User's Manual



www.stealthcam.net

Version 1.0

04/08

STC-I590

For Customer Service or Warranty Information Call Toll Free

877-269-8490

Stealth Cam, LLC

P.O. Box 539504

Grand Prairie, TX 75053-9504

www.stealthcam.net

Stealth Cam Limited Warranty

Your Stealth Cam scouting camera is covered by a 90 day Limited Warranty on parts and labor from the date of original purchase, and purchases must be made through an authorized dealer. The warranty covers defects in workmanship and materials. The warranty does not apply to units, which have been damaged or abused intentionally or unintentionally. A purchase from individuals or unauthorized internet sites voids the warranty.

Tampering with or altering the unit will void the warranty. Any unauthorized service will void warranty. Original sales receipt must be produced for any warranty service and a Return Authorization (RA) number must be obtained from customer service at 877-269-8490 prior to returning product.

www.stealthcam.net Toll Free 877-269-8490

Introduction

Thank you for purchasing the Stealth Cam STC-I590 digital video scout camera. Your Stealth Cam is designed to provide many years of service. The STC-I590 is a flash based camera with an industry leading flash range of up to 90 feet. Special Burst Mode technology allows multiple exposures of up to 9 sequential still pictures or a programmable video segment between 10 to 180 seconds, when the PIR sensor is triggered.

Contents

- STC-I590 Digital Video Scouting Camera
- User Manual
- USB cable
- Tree Mounting Strap

Table of Contents

Warranty	2
Introduction	3
Camera Kit Contents	4
Table of Contents	5
Overview	6-8
Battery Power Options	9-10
Built-in Memory & SD Card Installation	11-13
Description of Features	14-16
Programming Your Scout Camera	17-23
Using your Camera	24-29
Manual Shooting Mode	30
Viewing Images and Deleting Images	32-36
Formatting memory	37
Using External Power Source	38
Technical Specifications	39
Camera Features	40-41
General Information	42-43
Moon Phase Chart	44

www.stealthcam.net Toll Free 877-269-8490

STC-I590

Camera Overview - Front Cover Panel

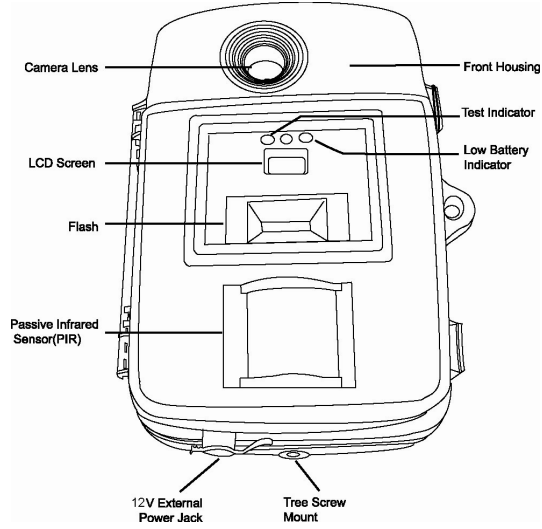

www.stealthcam.net Toll Free 877-269-8490

Camera Overview - Inside Control Panel

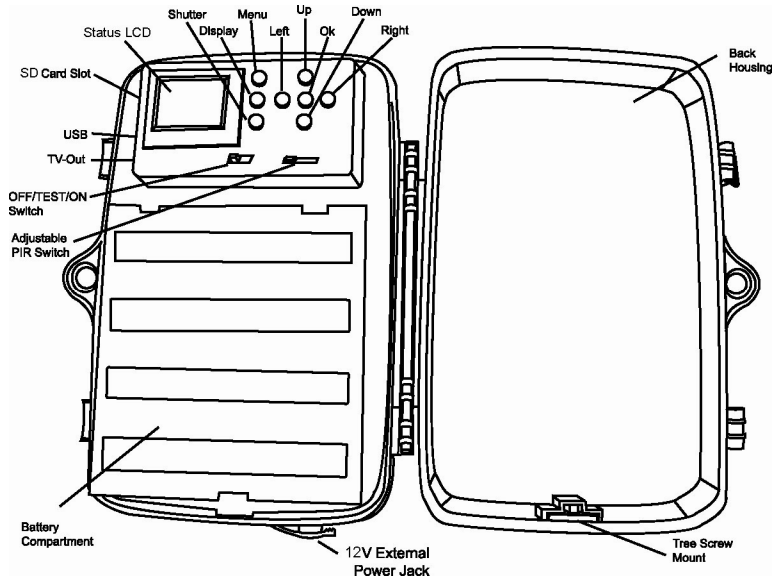

www.stealthcam.net Toll Free 877-269-8490

STC-I590

Camera Overview - Inside Side Panel

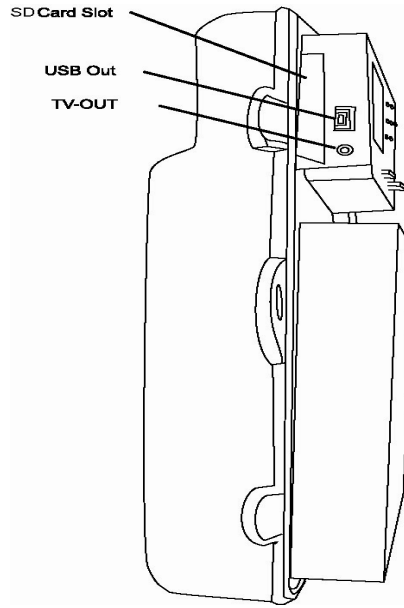

www.stealthcam.net Toll Free 877-269-8490

Battery Power Options

The Stealth Cam STC-I590 is designed to operate using two different battery power options. The camera must be in the OFF position when installing or removing batteries. Use of batteries other than those specified in this section may damage the camera and void your warranty.

Using “C” Cell Batteries

The internal battery compartment accepts 8 “C” cell batteries. Pull up on the bottom clip of the battery cover to open. Use fresh, high quality alkaline batteries. Install batteries in the correct polarity (+/-) referring to the illustration inside the battery compartment. Secure battery cover.

Precaution: When replacing batteries, [replace all the batteries within 10 minutes. Otherwise, this will result in the loss of date / time setting](#)

12V Lead Acid Battery (Recommended for extended field life)

To avoid replacing batteries when out in the field, the STC-I590 is equipped with an external power jack designed to accept a barrel plug cable that attaches to an optional lead acid battery (Stealth Cam STC-12VBB). Complete 12V Lead Acid battery kits offer significantly more usage than standard alkaline batteries. They are available at your Stealth Cam dealer, or call toll free (877) 269-8490. Only Stealth Cam external battery accessories are recommended.

Built-in Memory & SD Memory Card Installation

Your STC-I590 camera is equipped with 32MB of built in flash memory. The camera is also equipped with an expandable media card slot capable of accepting up to a 2GB SD card (sold separately). With no memory card inserted into the slot, the camera will use the built in flash memory to store images. If an SD card is inserted into the slot, then the camera will bypass the built in memory and utilize the SD card memory. The front counter display will show the number of images of either the built in flash memory or the inserted SD memory card after you turn on the camera.

Inserting the SD Memory Card

Make sure the camera is in the OFF position when you insert or remove a memory card.

- Insert SD memory card into the card slot completely, and in the correct direction as shown on the inside of the housing.
- To remove the SD memory card, push in the card and pull out the card gently.
- ❖ ***Brand new SD cards are ready for use. If you are using an SD card that was previously used in another camera, or other device, make sure to format the card prior to use in this camera.***
- ❖ **To ensure proper SD card formatting, insert it into the card slot and follow the steps page 37 to format the memory card.**

Image & Video Capacity

Capacity	High	Low	AVI (sec.)
32MB	20	65	120
64MB	40	130	240
128MB	80	260	480
256MB	160	520	960
512MB	320	1,040	1,920
1GB	640	2,080	3,840
2GB	1,280	4,160	7,680

NOTE: Picture / Image Capacity Chart provides approximate number of images or AVI video based on resolution settings and the size of memory card. These figures may vary depending on the amount of detail in the image.

Description of Features

Below are illustrations and descriptions of the icons you will see on the internal LCD screen as you enter specific modes for programming.

- **Auto Mode:**

- **Still images** – Captures from 1~9 pictures per PIR triggering











- **AVI video clip** – Captures video segments from 10s ~ 180s seconds per PIR triggering



- **Manual Mode:** Use as a point and shoot still image camera or video camera.

- **Flash Control:**

- Auto: In low light conditions, the flash will activate automatically. ⚡
- Flash Off: Turns off flash. (Flash icon will disappear)

- **Image Resolution:**
 - **2560 x 1920:** High image resolution 
 - **1600 x 1200:** Low image resolution 
 - **640 x 480** Default video resolution
- **Image Quality:**
 - One star = Low Quality 
 - Two stars = Normal Quality 
 - Three stars = High Quality 
- **Battery Status:**
 - **Full:** Batteries are full. 
 - **Half:** Batteries are half depleted. 
 - **Low:** Batteries are low. Front low battery LED indicator will flash. 
- **When the camera has detected low batteries, (lower than**
www.stealthcam.net Toll Free 877-269-8490

8.3 +/-0.2Volts for 12V C alkaline batteries; lower than 10.3+/-0.2Volts for External 12V Lead Acid battery) the camera unit will automatically power off within 30 seconds. Replace with new batteries as camera functions may not work properly.

- **Date and Time:** Date/Time stamp will be shown on all your images or the first frame of video files (using Windows Media Player or Real Player).
- **Moon Phase and Temperature:** Moon phase / temperature stamping on all still images.
- **Time Out:** To program the amount of time in minutes (1~60) that the camera will sleep between PIR triggering.

Programming your camera

Slide the power switch to TEST position. You will hear two short consecutive beeps followed by a third. Now you are ready to program your camera. Press the MENU button once to start your programming sequence.

For Manual Capture Mode

To capture still images or video clip using the manual shutter button.



The Camera icon or Video icon will flash:  

Press Left/Right button to select between manual **Still Image Mode** or manual **AVI Video Mode**. Press the OK button to confirm your setting, and then press Menu button to exit the programming mode. To continue manual capture mode, see page 30 for operating instructions.

For Auto capturing mode, press Menu again to begin your program setting sequence. You will see either your camera icon or video icon flashing.

Resolution

Press the DOWN button twice. The Resolution icon will flash.

Press Left/Right button to select either high resolution (2560 x 1920)  or low resolution (1600 x 1200) 

Press OK to confirm the setting, and the icon will stop flashing.

Press the Up button to change the previous setting, or the Down button to program the Quality setting.

NOTE: If you press **Menu** before pressing the OK button, you will exit the programming mode without saving your resolution setting.

Quality

The Quality icon will flash: 

Press Left/Right button to select between:

Fine – Normal – Low

One star = Low quality 

Two stars = Normal quality 

Three Stars = Fine quality 

STC-I590

2. Press Right button to enter the date setting.
3. Press Up/Down button to select the appropriate date.
4. Press Right direction button to enter the year setting.
5. Press Up/Down button to select the appropriate year.
6. Press Right button to enter the time setting.
7. Press Up/Down button to select the appropriate hour in military time.
8. Press Right button to enter minute setting.
9. Press Up/Down button to select the appropriate minutes.
10. Press Right direction button to enter the seconds setting.
11. Press Up/Down button to select the appropriate second.

At the end of the time setting, press OK to confirm and exit the setting menu.

Stealth Cam Settings – Burst Mode Technology

Stealth Cam digital cameras put you ahead of the game allowing you to set and Capture sequences by *programming 1-9 pictures per triggering, or 10 -180 seconds of video.*

To Program Still Image Burst Mode:

Slide the power switch from Off to Test position.

You will hear 2 consecutive short beeps follow by a 3rd beep. Press Menu button once, you will see the camera icon flashing. [Press OK to confirm this option.](#) Now press the DOWN button six times to scroll through all of the icon settings. You will now see the burst mode digit flashing.

Press Right button to select from 1 to 9 photos taken in sequence when the camera is triggered.

Press OK to confirm your Burst Mode photo setting.

Press the Down button to select the **Time Out** interval in minutes (1-60 min).

Press the Right button to increase the time interval by one minute increment or press the Left button to decrease the time interval by one minute increment.

Press OK to confirm.

To Program AVI clip Mode:

Slide the power switch from Off to Test position.

You will hear 2 consecutive short beeps follow by a 3rd beep. Press Menu button once, then press the Right Button once. You will see the Movie icon flashing. Press O.K. to confirm this option.

Now press the Down button six times to scroll through all of the icon settings. You will now see the AVI length setting digits flashing.

Press Right button to select from 10 seconds to 180 seconds of video clip each time the camera is triggered.

Press OK to confirm your AVI length setting.

Press the Down button to select the **Time Out** interval in minutes (1-60 min).

STC-I590

Press the Right button to increase the time interval by one minute increment or press the Left button to decrease the time interval by one minute increment.

Press OK to confirm.

Once all settings have been completed, press the MENU button to return to Camera Status Screen.

Using Your Camera

Once all program settings have been completed, your Stealth Cam is ready for field use. To begin, slide the power toggle switch from Test setting mode to the On position.

- ❖ ***Please note that when you power off the camera, the front LCD counter will remain on. This is normal.***

Getting Started With Your Camera

Mounting Your Camera

It is recommended to mount the camera 4~5 feet off the ground with the camera pointed at a slight downward angle. Avoid mounting the camera facing East or West as the rising and setting of the sun may produce false triggers and overexposed images. Clear branches and other debris away from the front of the camera so as not to block the camera lens or PIR sensor.

Mounting the Camera with Supplied Strap

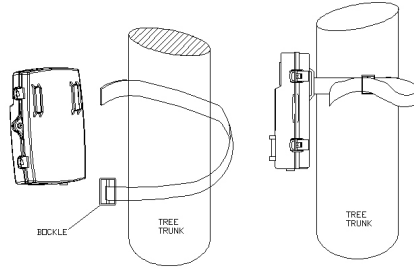

- Insert the strap through the strap slots on the rear housing.
 - Wrap the strap around the mounting surface. Secure the strap and tighten the buckle in order to secure the camera.
- ❖ ***In order to provide proper weather resistance, make sure that both door latches are securely locked in place.***

PIR Cover Area Diagram

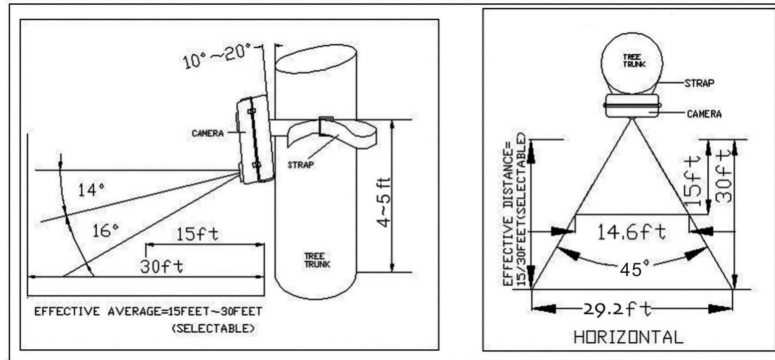

Adjust the PIR Coverage Distance

- Your Stealth Cam offers a variable PIR detection distance.
- The PIR dial has Near to Far coverage.
- NEAR is approximately 15 ft; FAR is approximately 30 ft.
- Select the desired coverage distance.

www.stealthcam.net Toll Free 877-269-8490

Testing the Camera Coverage Area

- After mounting the camera, open front housing and slide the power toggle switch to TEST.
- Close the front housing.
- Walk around in the front of the camera to see if you have mounted the camera in the proper position. A green indicator light on the front will blink when you have intruded the coverage area.
- Adjust the camera position as needed, and repeat testing until the desired coverage area is achieved.
- When you have completed testing the coverage area, open the front housing and slide the power toggle switch from TEST to ON position. This will exit the test mode. The camera will then enter one minute count down mode. The front green LED indicator will blink giving you one minute to leave the coverage area. Then the camera will enter PIR detection mode.

Using the Camera in PIR Detection Mode

- Mount the camera to a tree or other sturdy object using the supplied mounting strap. (Please refer to the mounting suggestions section in this manual)
- Open the front housing and slide the Toggle switch from OFF to TEST position. You will hear two short consecutive beeps followed by a third beep.
- The default setting of your Flash mode is set to Auto-Flash.
- The Auto-Flash icon will appear at the top right corner of the LCD screen. 
- To turn off Flash mode, press the **LEFT** button once. The flash icon will disappear. To return to auto flash mode, press the **LEFT** button one more time.
- Move the switch from Test to ON position to activate your PIR mode.
- The camera's green LED light will begin blinking and enter count down mode. This is your indication to leave the coverage area within one minute.
- After one minute, the camera will take between 1~9 pictures, or

AVI video clip based on your program settings. The camera will then time out between 1~60 minutes also based on your selection.

- ❖ ***The time between motion detection and the camera taking pictures may vary due to lighting and environment conditions, constant charging of the flash, program settings and battery power level.***
- ❖ ***The flash mode will only activate in low light conditions when set in Auto Flash.***
- ❖ ***AVI video operation is functional during day only. At night it will change into 1 picture flash capture mode.***

Manual Shooting Mode

Using Manual Shoot Option in Still image mode

- Slide the power toggle switch to TEST position. You will hear two short consecutive beeps followed by a third beep.
- Press the MENU button once. The Camera icon will flash.
- For still image capturing, press OK to select this option and press Menu to exit to status screen.
- Camera icon will stop flashing on the LCD screen to indicate still image mode.
- Point and hold the camera steady in the direction to capture an image, and press the SHUTTER button once. Wait for the one short beep follow by two consecutive beeps. This indicates the image has been captured, and the LCD counter will update the number of images in memory.
- When taking night time pictures, allow approximately 7 seconds between shots to allow the flash to charge. In case of low battery power, it will take longer to charge the flash between pictures.

Using Manual Shoot Option in AVI Mode

- Slide the power toggle switch to TEST position. You will hear two short consecutive beeps followed by a third beep.
- Press the MENU button. The Camera icon will flash.
- Press RIGHT button to select manual Video Capture Mode. Video icon will display on the LCD screen to indicate AVI mode 
- Press OK to confirm setting, and the icon will stop flashing.
- Press MENU to exit settings.
- Point and hold the camera steady in the direction to capture the video. Press the SHUTTER button to start video recording. You will hear one beep as an indication that the recording process has started.
- Press the SHUTTER button a 2nd time to stop video recording. You will hear one beep as an indication that the recording has stopped and you will see the front counter digit updated.

(Note: Make sure to press the SHUTTER button a 2nd time to stop video recording, otherwise it will record video indefinitely until the memory capacity is reached, or until

you turn the power off.)

Viewing Images

The STC-I590 cam offers the user different options for viewing the images. The external LCD display on the front of the housing will show the number of images in memory.

Download to PC to View Images

The Stealth Cam STC-I590 Digital Scouting Camera is a plug and play unit for users of Windows XP, 2000, and ME operating systems, and need not install a camera driver. If your PC operating system is older, then visit www.stealthcam.net to download the appropriate camera driver.

NOTE: Users of Windows 98SE or earlier must download and install the camera driver prior to connecting the USB cable.

- Make sure the Power switch is in the OFF position before connecting the USB cable to the camera.
- After you connect the USB cable to the computer, you will see a small USB ICON on the upper left hand corner of the LCD screen.

STC-I590

- For a plug and play operating system, your computer will recognize the camera as mass storage unit and allow you to see the images stored in the camera, or images on the SD card if you are using one.

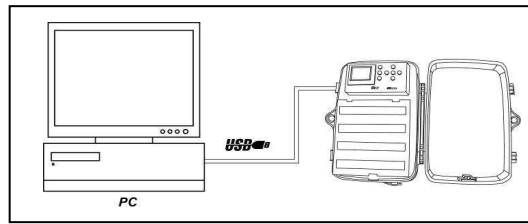

Viewing the images on a handheld LCD TV video monitor, or your home TV equipped with an RCA input jack (cables sold separately)

For viewing on a handheld LCD TV, attach the appropriate cable to the video OUT jack on the camera. Insert the other end into the video IN jack on the handheld LCD TV monitor.

For viewing on your home TV, attach the appropriate cable to the

video OUT jack on the camera. Insert the other end into the RCA video IN jack on the TV. Make **sure to switch to VIDEO IN mode on your TV. (See your TV owner's manual for directions)**

Turn on the TV monitor and slide the camera power switch to TEST.

- [Your camera is preset to NTSC TV out system by default.](#)
- Press the OK button on the camera. This will display the last image captured.
- Using the LEFT/RIGHT buttons to select the image you wish to view. Image number and total number of images in memory will display on the center bottom of the screen.
- Once you have selected the image you wish to view, press the UP button. This will magnify the image on the screen.
- Using LEFT/RIGHT/UP/DOWN buttons, you can move the image to display different areas of the image.
- To return to the image selection view from the magnified image screen, press the OK button.

Viewing AVI Clip on a hand held TV or home TV monitor

- Follow the cable attaching instruction listed in the hand held TV

STC-I590

or home TV monitor described in previous section.

- Press the OK button on the camera. This will display the last image captured.
- Press LEFT / RIGHT button to scroll through the images in memory. An AVI motion clip image will have a video icon showing on the upper left hand corner of the image.
- Press SHUTTER button to play back the AVI motion clip.
- To return to image selection view, press LEFT / RIGHT button at the end of the AVI clip.

NOTE: Depend on the type of TV that you are using, you may not be able to see the date/time stamp shown on the bottom of the picture. Rest assures it is there.

Deleting Images

At any time while viewing images on a Handheld TV or home TV monitor, you may delete images one at a time or all at once.

- While viewing images in normal view, press MENU to enter the DELETE menu.
- By default your viewing monitor will display DEL 1. Use the LEFT/RIGHT button to choose the desired function to delete one picture at a time, DEL 1, or delete all pictures at one time, DEL All.
- Press OK to enter Delete Mode. Press LEFT/RIGHT button to choose either YES or NO to proceed with this function.
- Press OK again to confirm deleting image. After deleting image, camera will return to picture viewing mode.

Formatting Memory Card

To erase images stored in memory, or to format an SD card:

Slide the power switch to TEST position. You will hear two short consecutive beeps followed by a third beep.

- Press Menu button once
- Press the Down button once
- The Trash icon will flash.  Press OK to confirm you want to format the memory.
- The word “no” and the Trash icon will be flashing. If at this time you decide not to proceed with the formatting of the memory, press OK to exit. Otherwise press the Left button once. The word “yES” and the Trash icon will flash. Press OK to confirm you want to proceed with formatting the memory.

Using External Power

The Stealth Cam STC-I590 is designed to be used with an optional external 12V lead acid battery kit (STC-12VBB- sold separately). It is recommended for use in cold weather environments, or situations where your camera would be unattended for long periods of time.

- ❖ *Make sure to install cables in correct polarity (+/-) with a lead acid battery. Incorrect voltage or polarity (+/-) will result in damage to the camera.*

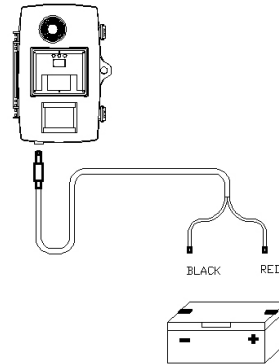

Technical Specifications

System Requirements and Compatibility

- Windows 98se / 2000 / ME / XP
- P 450MHz or equivalent processor.
- 128MB SDRAM or above.
- VGA Video Card with 32MB RAM for minimum, Color 16 bit or higher.
- An available USB Port.

If you have any questions regarding your PC specifications, please call your PC manufacturer.

Camera Features

- Image sensor: 2 mega-pixel (Interpolation) RGB color
- Built in 1.8" B&W LCD display
- Built in 32MB flash memory for image & video storage
- External memory support: SD memory card up to 2GB
- Resolution Options: High (2560 x 1920), Lower (1600 x 1200)
- Quality Options: Low, Normal, Fine
- 4 Capturing Options:
 - ❖ Manual : Single or Video (AVI)
 - ❖ PIR activation : 1~9 Burst mode or adjustable Video clip
- Video performance: 10fps in 640 x 480
- Auto white balance and auto exposure
- Flash Range: 90 feet
- Flash Mode Auto / Off control
- Military Time Format for date and time stamping
- Time/Date/Moon Phase/Temperature Stamping on all images
- Time/Date Stamping on first video frame (WMV & Real Player)

www.stealthcam.net Toll Free 877-269-8490

STC-I590

- 4 digits LCD Image counter; Battery low indicator
- Green Test LED indicator for area detection
- TV out support for NTSC system
- High precision 3P glass lens with IR coating
- Effective viewing Angle: 54 deg; Focus: 15 feet ~ Infinity
- PIR detection angle 45 degrees
- Adjustable PIR detection range up to 30ft
- Low power consumption:
Standby current: < 1 mA; Capture current <150mA
- Interface type: USB
- Power: C size alkaline batteries x 8 (not included)
- Image format: Standard JPEG & Motion JPEG (AVI)

General Information

Storing conditions

- Store in cool and dry location when it's not in use.
- Operating Environment: 14 to 104 deg F (-10 to 40 deg C).
20-85% relative humidity, non-condensing

Special Care Instructions

- The camera is designed to be weather resistant. Never attempt to immerse the unit in water or any other liquid. This will damage the unit and void the warranty.
- Use a soft lens cloth for cleaning the lens. Avoid touching the lens with your fingers.
- Remove dirt or stains with a soft cloth dampened with water or neutral detergent. Keep the camera in a dry and cool dust-free environment or container when NOT in use.
- Take the batteries out when the camera will not be used for an extended period of time.
- Avoid dropping the camera on to hard surfaces. Do not disassemble the camera.

STC-I590















- Do not mix new and old batteries.
- Always use fresh batteries
- For longer battery performance, use the Stealthcam lead acid 12V battery pack (optional).
- Do not open the camera in an attempt to do an unauthorized service. This may cause serious damage to the unit and will void the warranty.

This camera is a precision electronic device. Do not attempt to service this camera yourself, as opening or removing covers, may expose you to dangerous voltage points or other risks.

May be protected by one or more U.S. Patent numbers:

6,735,387 / 6,768,868 / 6,834,162 / 7,149,422 / 7,308,196

Moon Phase Symbol Chart

Symbol	Lunation from to		Actual phase
	1	5	
	6	10	
	11	14	
	15	16	
	17	20	
	21	25	
	26	29 or 30	

Product specifications are subject to change. Stealthcam is not responsible for any photographic or typographical errors.

www.stealthcam.net Toll Free 877-269-8490